

seko

Duotek

Air operated double diaphragm pumps



Your Choice,
Our Commitment

info@createflow.cz
www.createflow.cz

Craete Flow s.r.o.

tel: 00420 722 712 652

SEKO's Duotek pumps are reknown for their flexibility in pumping difficult liquids at low pressure and flow.

SEKO's **Duotek pumps** come in many sizes and choices of materials of construction. Almost every type of liquid from highly corrosive acids through high viscosity paints and adhesives, to food and drink products can be pumped. The range of applications is virtually limitless.

Performance

- Variable flow and head pressures, easy to adjust, without sophisticated controls
- Portable and compact for multi-location use, optionally with trolley
- Handles liquids with solids particles: ideal for abrasive and viscous media
- Special Air system: lube-free, non-stall, non-freeze
- Wide Range of sizes and materials suited to variety of conditions and chemical fluids
- Efficient performance: high flow rates through optimal casing designs
- Self-priming dry up to 6 meters: works in suction lift applications
- Efficient air distribution design: low air consumption
- Can customize to specific applications: multiple porting options available along with interface options
- Safe "dead head" function, against closed discharge, without pump damage

Reliability

- 100% wet tested after final assembly: deadheading, priming, and sealing
- All plastic air system: strong and corrosion resistant in harsh environments
- Dry-run without damaging the pump or system: seal-less design
- Service ability: easily maintained and quickly without any special tools

Security

- ATEX certifications in all versions: Conductive plastic pumps available
- Special air exhaust: Designed to operate at low noise levels
- Fully submersible: can be submerged completely according to fluid compatibility
- All Bolted Construction: provides maximum leak resistance and safety





Markets and Applications

Air operated double diaphragm pumps are some of the most versatile solutions on the market. They can be used in a variety of installations in numerous applications.

- AUTOMOTIVE
- AGRICULTURE
- MECHANICAL
- CHEMICAL
- CERAMIC
- FOOD
- BIODIESEL
- CERAMIC
- TEXTILE AND LEATHER
- PAINT AND VARNISH
- NAVAL AND PETROCHEMICAL
- PULP AND PAPER
- MINING
- PHARMACEUTICAL AND COSMETIC
- GALVANIC
- OIL & GAS
- WATER TREATMENT
- PRINTING INKS

Why choose Duotek

Pump type	AODD	CENTRIFUGAL	LOBE	GEAR	SCREW	PERISTALTIC	PISTON
Variable Flow & Head Control	✓	✓	✓	✓	!	!	✓
Deadhead Safely	✓	✓	!	!	!	!	!
Dry-Running	✓	X	X	X	X	X	X
Dry Self-Priming	✓	X	X	✓	X	✓	!
No Mechanical Alignment	✓	X	X	X	X	X	X
No Electrical Installation	✓	X	X	X	X	X	X
Portability	✓	✓	!	!	!	✓	!
Submersible	✓	!	X	X	X	X	!
Seal-less	✓	!	!	!	!	!	!
Cavitation Tolerance	✓	X	!	!	✓	!	!
Low Shear & Degradation	✓	X	✓	✓	!	!	!

✓ = Suitable ! = Limitations X = Not Recommended

Materials PUMP CASING

Polypropylene



P Polypropylene: Wide chemical compatibility. General purpose.

Polypropylene+CF



C Conductive Polypropylene: Wide chemical compatibility. General purpose. Groundable.

PVDF+CF



K Conductive PVDF: Strong chemical resistance to acids. High temperature resistance. Groundable..

POMc



M Acetal: Wide range of solvent and hydrocarbons resistance. Good level of abrasion resistance.

POMc+CF



N Conductive Acetal: Wide range of solvent and hydrocarbons. Good level of abrasion resistance. Groundable.

Aluminium



A Aluminium: Wide range of solvent and hydrocarbons. Good level of abrasion resistance.

SS316



S Stainless Steel 316: High level of corrosion and abrasion resistance.

SS316 Electropolished



S Stainless Steel 316 Electropolished: High level of corrosion and abrasion resistance. Food Version.

Materials

Diaphragm



NBR Good for petroleum-based fluids, water, oils, hydrocarbons and MILD chemicals.

EPDM OK with caustic solutions, dilute acids, ketones and alcohols. Good abrasion resistance.

PTFE Widest chemical compatibility, extreme corrosion resistance, non-adhesive, high heat resistance.

HYTREL Good low temperature properties. Good abrasion resistance.

SANTOPRENE Solutions and dilute acids.

Ball Check

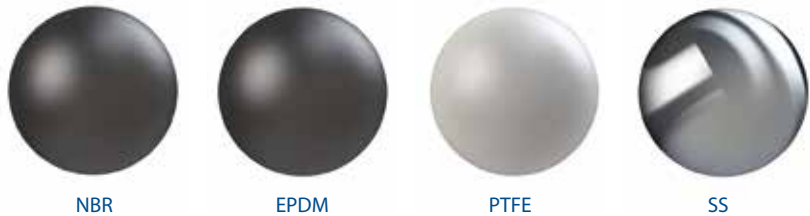

NBR Good for petroleum-based fluids, water, oils, hydrocarbons and MILD chemicals.

EPDM OK with caustic solutions, dilute acids, ketones and alcohols. Good abrasion resistance.

PTFE Widest chemical compatibility, extreme corrosion resistance, non-adhesive, high heat resistance.

SS High level of corrosion and abrasion resistance. Good for viscous fluids.

Seat



POLYPROPYLENE Wide chemical compatibility. General purpose.

PVDF Strong chemical resistance to acids. High temperature resistance.

ALUMINIUM Wide range of solvent and hydrocarbons. Good level of abrasion resistance.

SS High level of corrosion and abrasion resistance.

PE with high molecular weight: High level of abrasion resistance

O-rings



VITON High heat resistance. Good resistance to aggressive chemicals and hydrocarbons.

NBR Good for petroleum-based fluids, water, oils, hydrocarbons and MILD chemicals

EPDM OK with caustic solutions, dilute acids, ketones and alcohols. Good abrasion resistance.

PTFE Widest chemical compatibility, extreme corrosion resistance, non-adhesive, high heat resistance.

Technical features

Un-balanced pilot spool, precisely controls positioning of the main power spool to eliminate stalling and increase efficiency

Long-lasting diaphragm construction ensures a consistent performance and a longer operating life

Special exhaust chamber with double silencer to expand diffusion passages, reduce the icing and assure low noise level

Acetalic shuttle ensures long valve life, auto-lubricated material

Special pinch clamping, design to minimize wear and increase life of the diaphragm, and provides a uniform seal to avoid leak

Pneumatic exchanger is easily externally accessible for a quick inspection

Solid polypropylene air chambers and plastic air valve for maximum chemical resistance in highly corrosive environments

All bolted design for an effective sealing to extended leak-proof service

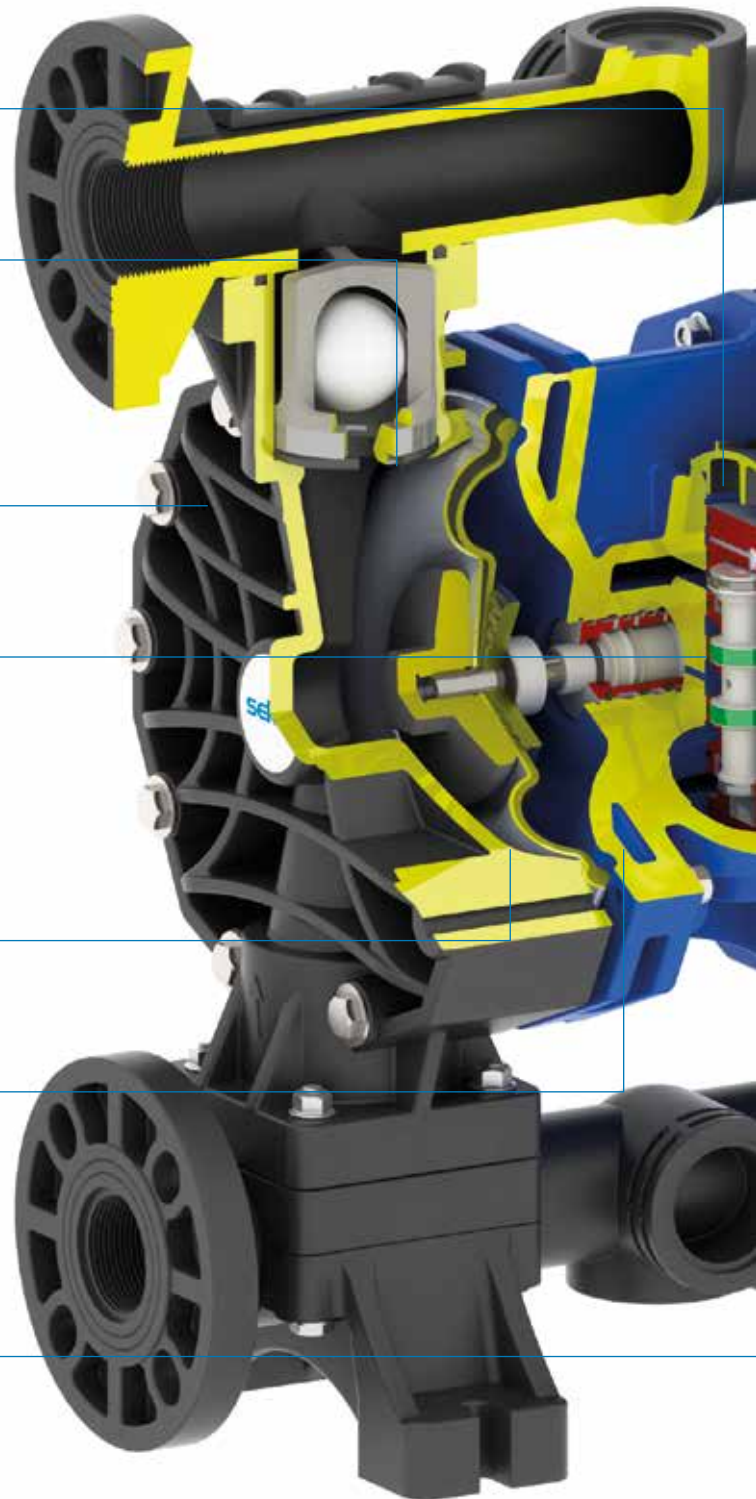

Product range

DUOTEK



Air operated double diaphragm pumps made in PP, PVDF, ALUMINIUM, SS AISI 316, POMc with a flow rate from 8 l/min to 1000 l/min and connection from ¼" to 3".



DUOTEK FOOD



Air operated double diaphragm pumps made in SS AISI 316 electro-polished with a flow rate from 8 l/min to 1000 l/min and Tri-Clamp Connection.



DUOTEK ATEX



Air operated double diaphragm pumps, ATEX certified for zone 1. Made in PP+CF, PVDF+CF, ALUMINIUM, SS AISI 316, POMc+CF with flow rate from 8 l/min to 1000 l/min and connection from ¼" to 3".



DUOTEK ACCURATE



Double diaphragm pumps with remote control made in PP, PVDF, ALUMINIUM, SS AISI 316, POMc with flow rate from 8 l/min to 700 l/min and connection from ¼" to 2".



DUOTEK DRUM



Air operated double diaphragm pumps with special features to empty drums and tanks. made in PP, PVDF, ALUMINIUM, SS AISI 316, POMc with flow rate from 8 l/min to 160 l/min and connection from ¼" to 1".



DUOTEK TWIN



Air operated double diaphragm pumps with special features with double inlet/outlet. Made in PP, PVDF, ALUMINIUM, SS AISI 316, POMc with flow rate from 8 l/min to 700 l/min and connection from ¼" to 2".



DAMPER



Pneumatic, automatic pulsation dampers made in PP, PVDF, ALUMINIUM, SS AISI 316, POMc, applicable to all sizes of pump. Available also in ATEX or FOOD version.



Duotek - Key Code

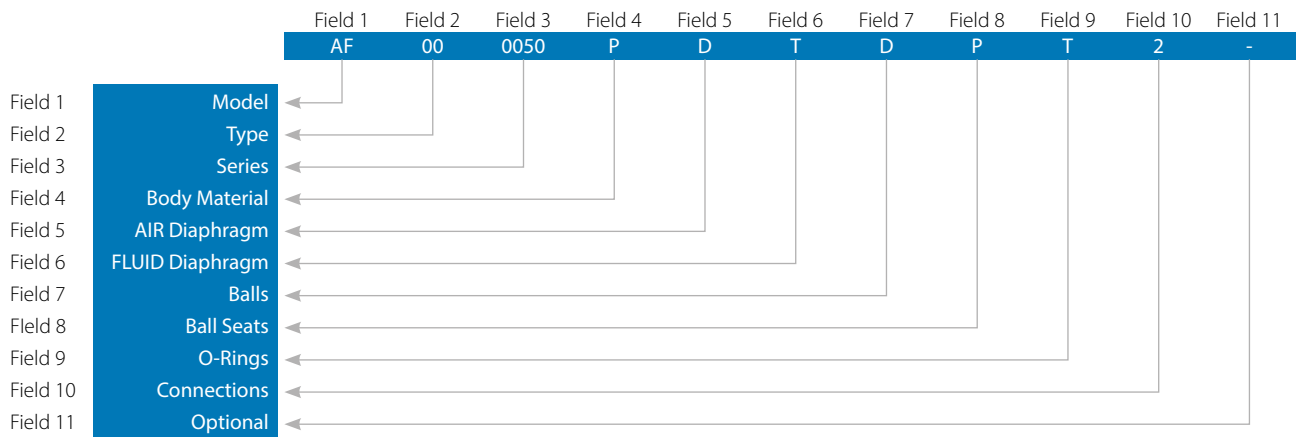

Field 1 **Model**
 AF Pneumatic Diaphragm Pumps

Field 2 **Type**
 00 Zone 2 ATEX
 X0 Zone 1 ATEX

Field 3	Series	Flow rate [l/m]	Connections [BSP]		° Suction lift max [m]	Delivery head max [m]	Solid passing [0mm]	Displac. / cycle [cc]	Viscosity max [cps]
			Fluid	Air					
	0007	8	1/4"	4mm	3	80	2.5	18	6,000
	0018	20	3/8"	6mm	6		3	30	12,000
	0030	35	1/2" *				1/4"	65	15,000
	0050	55		140				20,000	
	0065	70	3/8"	200			25,000		
	0100	110					3/4" *	7.5	700
	0160	170	1" *	1/2"			8	1,200	40,000
	0250	250	1"1/4 *				8.5	3,050	50,000
	0400	380	DN40 - 1"1/2	3/4"			10	7,000	55,000
	0700	700	DN50 - 2"						
	1000	1050	3" **						

* FLANGED: add the cost of the related KIT ** THREADED: on request
 ° With Dry pump. To WET pump: 9.38m Max AIR pressure: 8 bar

Field 4 **Body Material**

P	Polypropylene + Glass Fiber	
C	Polypropylene + Carbon Fiber	Field 2: X0
K	PVDF + Carbon Fiber	
A	Aluminium	
S	SS 316	
M	POM + Carbon Fiber	
N	POM	Field 2: X0

Field 5	AIR Diaphragm	H Hytrel
		M Santoprene
		D EPDM
		N NBR
Field 6	FLUID Diaphragm	T PTFE
		X without Diaphragm PTFE
Field 7	Balls	T PTFE
		S SS 316
		D EPDM
		N NBR
Field 8	Ball Seats	P Polypropylene
		K PVDF pure
		S AISI 316
		A Aluminium
		M POMc
		Z PE
Field 9	O-Rings	D EPDM
		V FPM
		T PTFE
		N NBR
Field 9	Connections	1 BSP Threaded
		2 Flanged
		4 Twin connection
		5 NPT Threaded
		6 Reinforcement ring
		7 Extra connections
Field 9	Optional	- None
		E External pump control WITH solenoid
		D External pump control WITHOUT solenoid

Duotek

Air operated double diaphragm pumps

Air operated double diaphragm pumps have long been recognized as the most flexible pumps of the industry for handling difficult liquids at relatively low pressures and flows. The range of applications is virtually limitless. SEKO AODD pumps come in many sizes and choices of materials of construction. Almost every type of liquid from highly corrosive acids through high viscosity paints and adhesives, to food and drink products can be pumped.

Made in PP, PVDF, ALUMINIUM, SS AISI 316, POMc

Flow rate from 8 l/min to 1000 l/min

Connection from 1/4" to 3"

ATEX certification for zone 2

EX II 3/3 GD c IIB T135°C



Duotek AF7

 EX II 3/3 GD c IIB T 135°C

Technical data

Fluid connections	1/4" BSP
Air connection	4 mm
Max flow rate	8 l/min
Max air pressure	8 bar
Max delivery head	80 m
Max suction lift dry	3 m
Max suction lift wet	9.8 m
Max solid passing	2.5 mm
Noise level	62 dB
Max viscosity	6000 cps



PP



PVDF+CF

POMc

Duotek AF18

 EX II 3/3 GD c IIB T 135°C

Technical data

Fluid connections	3/8" BSP
Air connection	6 mm
Max flow rate	20 l/min
Max air pressure	8 bar
Max delivery head	80 m
Max suction lift dry	6 m
Max suction lift wet	9.8 m
Max solid passing	3 mm
Noise level	65 dB
Max viscosity	12000 cps

PP



PVDF+CF



POMc



SS316

Duotek AF30

 EX II 3/3 GD c IIB T 135°C

Technical data

Fluid connections	1/2" BSP
Air connection	6 mm
Max flow rate	35 l/min
Max air pressure	8 bar
Max delivery head	80 m
Max suction lift dry	5 m
Max suction lift wet	9.8 m
Max solid passing	3.5 mm
Noise level	65 dB
Max viscosity	15000 cps

PP



PVDF+CF



POMc



SS316

Duotek AF50

 EX II 3/3 GD c IIB T 135°C

Technical data

Fluid connections	1/2" BSP
Air connection	1/4" BSP
Max flow rate	55 l/min
Max air pressure	8 bar
Max delivery head	80 m
Max suction lift dry	6 m
Max suction lift wet	9.8 m
Max solid passing	3.5 mm
Noise level	68 dB
Max viscosity	20000 cps



PP



PVDF+CF

ALU

SS316

Duotek AF65

 EX II 3/3 GD c IIB T 135°C

Technical data

Fluid connections	1/2" BSP
Air connection	3/8" BSP
Max flow rate	70 l/min
Max air pressure	8 bar
Max delivery head	80 m
Max suction lift dry	6 m
Max suction lift wet	9.8 m
Max solid passing	3.5 mm
Noise level	72 dB
Max viscosity	25000 cps



PP



PVDF+CF

ALU

SS316

Duotek AF100

 EX II 3/3 GD c IIB T 135°C

Technical data

Fluid connections	3/4" BSP
Air connection	3/8" BSP
Max flow rate	110 l/min
Max air pressure	8 bar
Max delivery head	80 m
Max suction lift dry	6 m
Max suction lift wet	9.8 m
Max solid passing	3.5 mm
Noise level	72 dB
Max viscosity	25000 cps



PP



PVDF+CF



ALU



SS316

Duotek AF160

 EX II 3/3 GD c IIB T 135°C

Technical data

Fluid connections	1" BSP
Air connection	1/2" BSP
Max flow rate	170 l/min
Max air pressure	8 bar
Max delivery head	80 m
Max suction lift dry	6 m
Max suction lift wet	9.8 m
Max solid passing	7.5 mm
Noise level	75 dB
Max viscosity	35000 cps



PP



PVDF+CF



ALU



SS316

Duotek AF250

 EX II 3/3 GD c IIB T 135°C

Technical data

Fluid connections	1" 1/4 BSP
Air connection	1/2" BSP
Max flow rate	250 l/min
Max air pressure	8 bar
Max delivery head	80 m
Max suction lift dry	6 m
Max suction lift wet	9.8 m
Max solid passing	7.5 mm
Noise level	75 dB
Max viscosity	35000 cps



PP



PVDF+CF



ALU



SS316

Duotek AF400

 EX II 3/3 GD c IIB T 135°C

Technical data

Fluid connections	1" 1/2 BSP DN 40
Air connection	3/4" BSP
Max flow rate	380 l/min
Max air pressure	8 bar
Max delivery head	80 m
Max suction lift dry	5 m
Max suction lift wet	9.8 m
Max solid passing	8 mm
Noise level	78 dB
Max viscosity	40000 cps



PP



PVDF+CF



ALU



SS316

Duotek AF700

 EX II 3/3 GD c IIB T 135°C

Technical data

Fluid connections	2" BSP DN 50
Air connection	3/4" BSP
Max flow rate	700 l/min
Max air pressure	8 bar
Max delivery head	80 m
Max suction lift dry	5 m
Max suction lift wet	9.8 m
Max solid passing	8.5 mm
Noise level	78 dB
Max viscosity	50000 cps



PP



PVDF+CF

ALU

SS316

Duotek AF1000

 EX II 3/3 GD c IIB T 135°C

Technical data

Fluid connections	3" BSP DN 80
Air connection	3/4" BSP
Max flow rate	1050 l/min
Max air pressure	8 bar
Max delivery head	80 m
Max suction lift dry	5 m
Max suction lift wet	9.8 m
Max solid passing	10 mm
Noise level	78 dB
Max viscosity	55000 cps



PP



PVDF+CF

ALU

SS316

Performance curves

The curves and performance values refer to pumps with submerged suction and a free delivery outlet with water at 20°C, and vary according to the construction material.

○ Air supply pressure ○ Air consumption Nlt/min

Duotek AF7

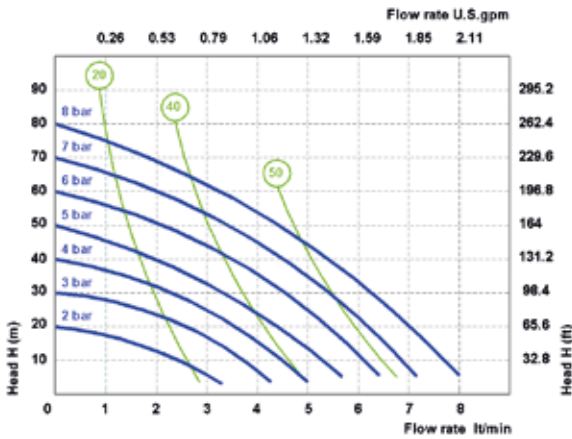

Duotek AF18

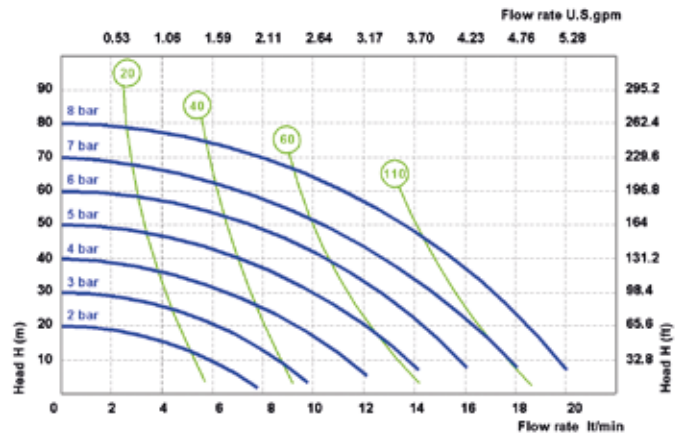

Duotek AF30

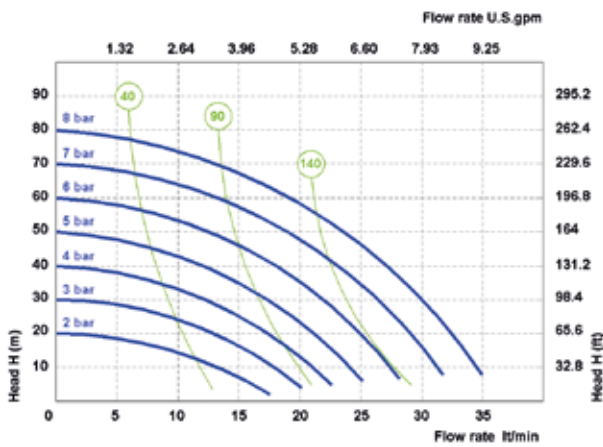

Duotek AF50

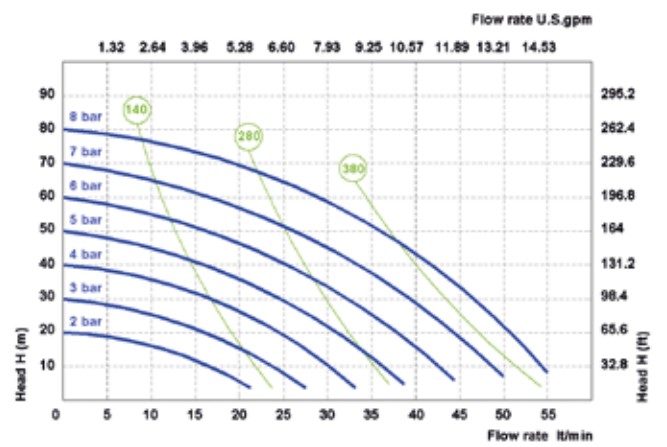

Duotek AF65

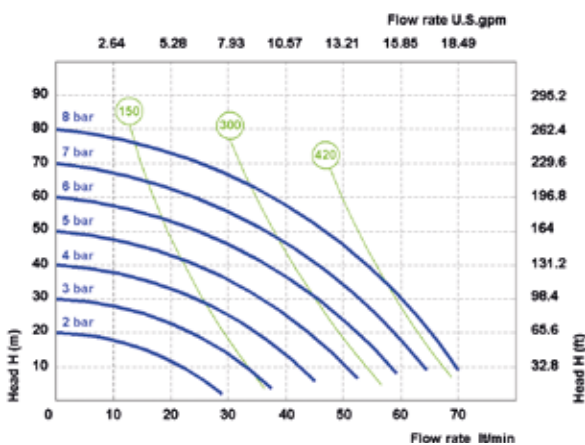

Duotek AF100

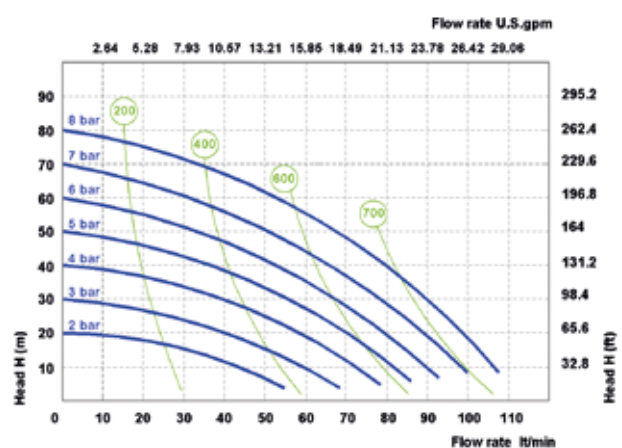

Duotek AF160

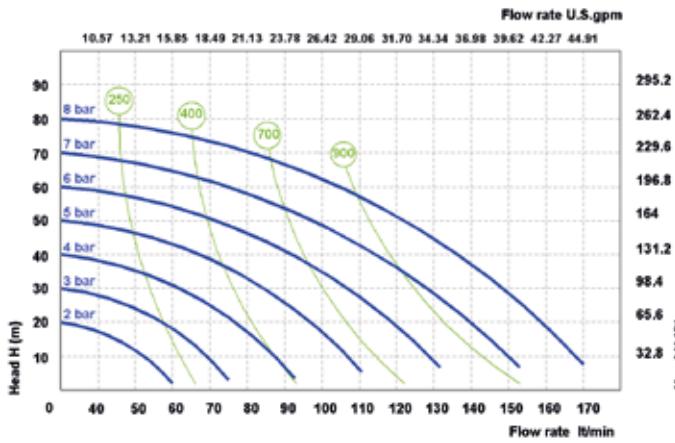

Duotek AF250

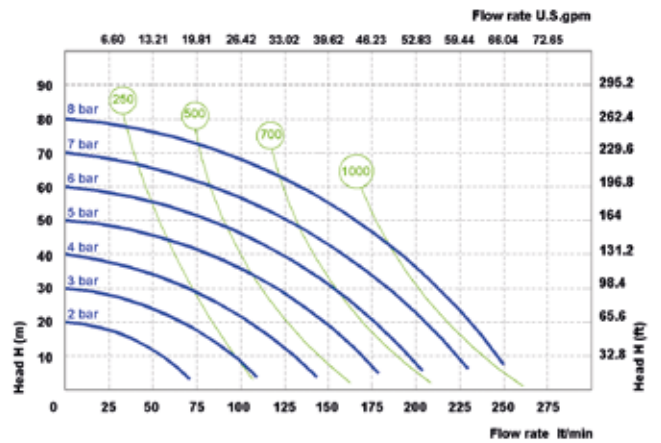

Duotek AF400

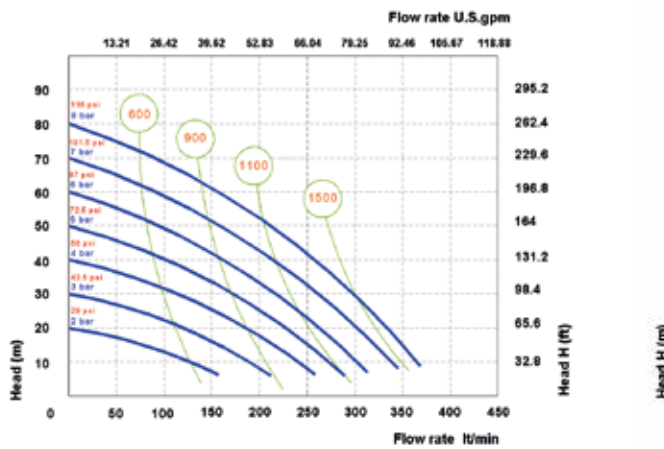

Duotek AF700

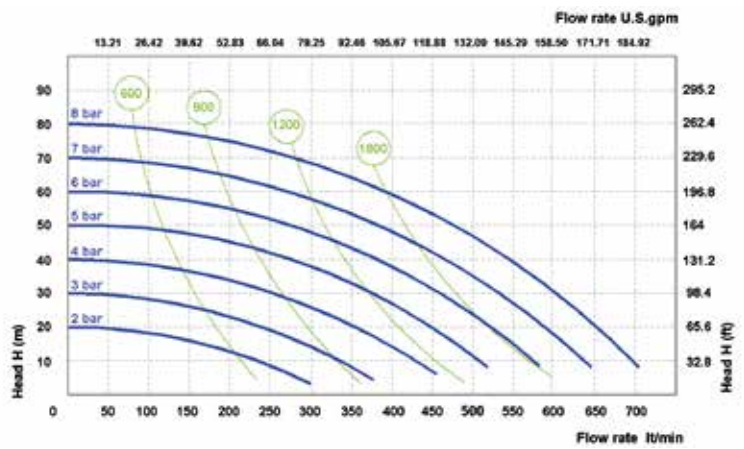

Duotek AF1000

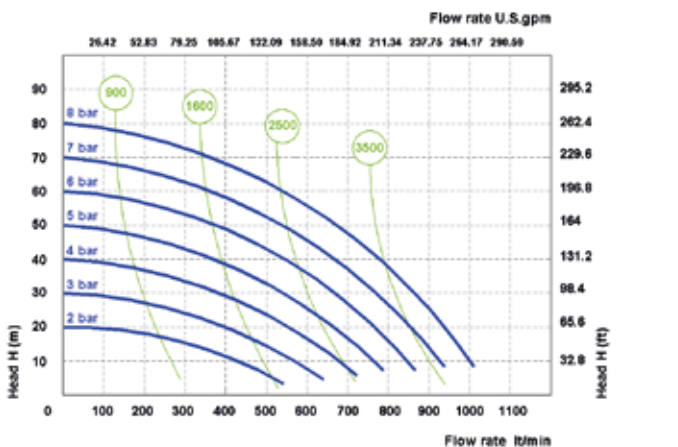

Duotek Food

Air operated double diaphragm pumps

Made in SS316 electro-polished
Flow rate from 8 l/min to 1000 l/min
Tri-Clamp Connection
ATEX certification
Atex zone 2 - EX II 3/3 GD c IIB T 135°C
Atex zone 1 - EX II 2/2 GD c IIB T 135°C



Duotek Food AF18



Technical data

Fluid connections	Tri-Clamp 1/2"
Air connection	6 mm
Max flow rate	20 l/min
Max air pressure	8 bar
Max viscosity	12000 cps



SS316 ELECTRO-POLISHED

Duotek Food AF30



Technical data

Fluid connections	Tri-Clamp 1"
Air connection	6 mm
Max flow rate	35 l/min
Max air pressure	8 bar
Max viscosity	15000 cps



SS316 ELECTRO-POLISHED

Duotek Food AF50



Technical data

Fluid connections	Tri-Clamp 1"
Air connection	1/4" BSP
Max flow rate	55 l/min
Max air pressure	8 bar
Max viscosity	20000 cps



SS316 ELECTRO-POLISHED

Duotek Food AF100



Technical data

Fluid connections	Tri-Clamp 1"
Air connection	3/8" BSP
Max flow rate	110 l/min
Max air pressure	8 bar
Max viscosity	25000 cps



SS316 ELECTRO-POLISHED

Duotek Food AF160



Technical data

Fluid connections	Tri-Clamp 1 1/2"
Air connection	1/2" BSP
Max flow rate	170 l/min
Max air pressure	8 bar
Max viscosity	35000 cps



SS316 ELECTRO-POLISHED

Duotek Food AF400



Technical data

Fluid connections	Tri-Clamp 2"
Air connection	3/4" BSP
Max flow rate	380 l/min
Max air pressure	8 bar
Max viscosity	40000 cps



SS316 ELECTRO-POLISHED

Duotek Food AF700



Technical data

Fluid connections	Tri-Clamp 2 1/2"
Air connection	3/4" BSP
Max flow rate	700 l/min
Max air pressure	8 bar
Max viscosity	50000 cps



**SS316
ELECTRO-
POLISHED**

Duotek Food AF1000



Technical data

Fluid connections	3" BSP
Air connection	3/4" BSP
Max flow rate	1050 l/min
Max air pressure	8 bar
Max viscosity	55000 cps

**SS316
ELECTRO-
POLISHED**



Performance curves

The curves and performance values refer to pumps with submerged suction and a free delivery outlet with water at 20°C, and vary according to the construction material.

○ Air supply pressure ○ Air consumption Nl/min

Duotek Food AF18

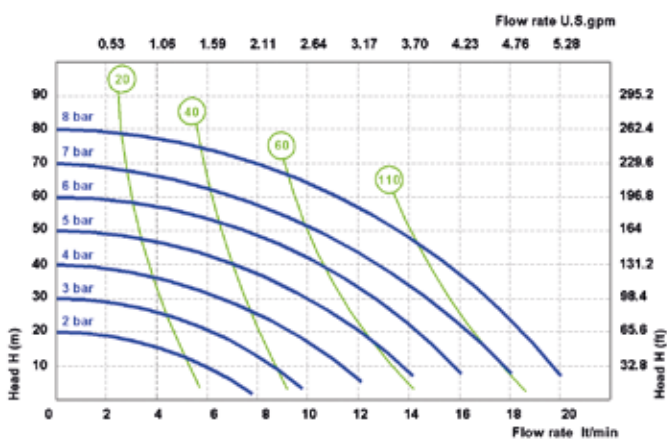

Duotek Food AF30

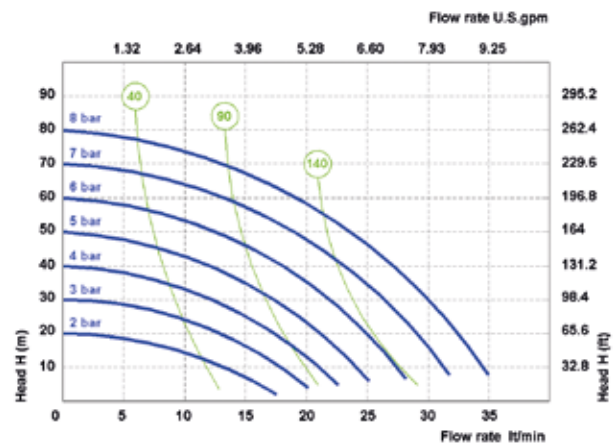

Duotek Food AF50

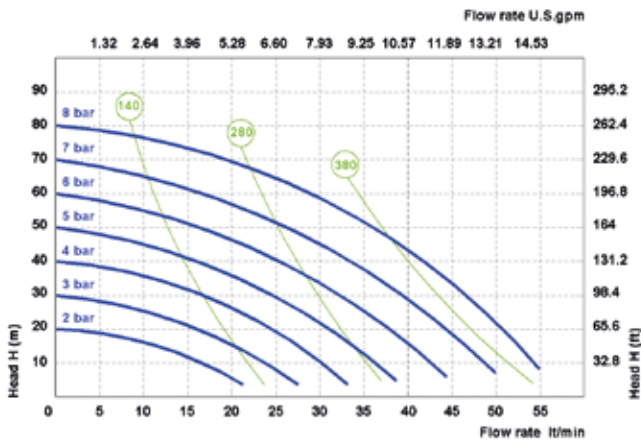

Duotek Food AF100

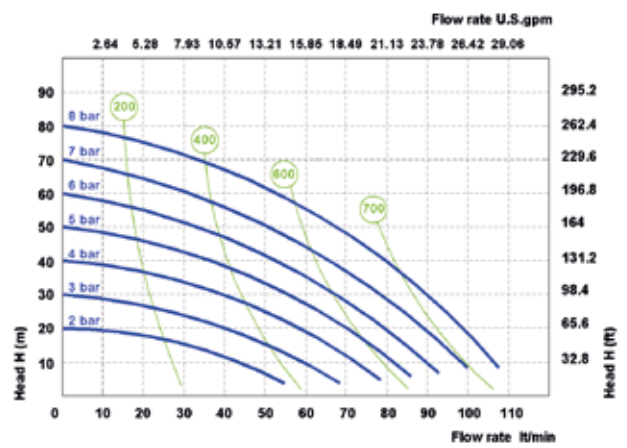

Duotek Food AF160

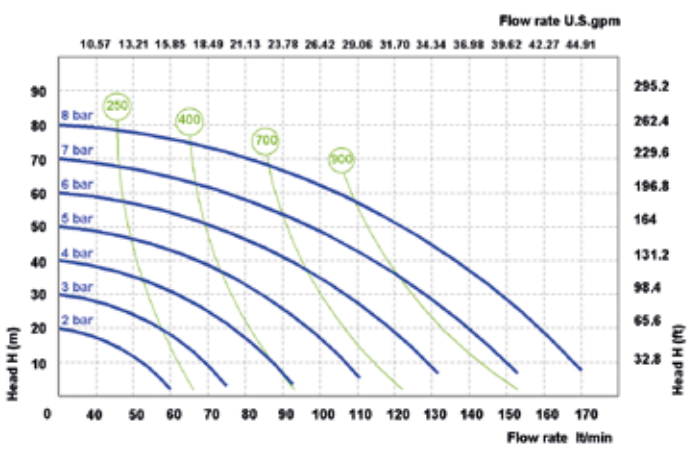

Duotek Food AF400

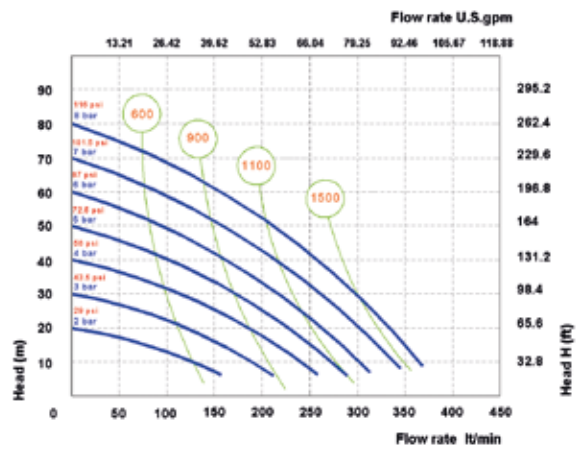

Duotek Food AF700

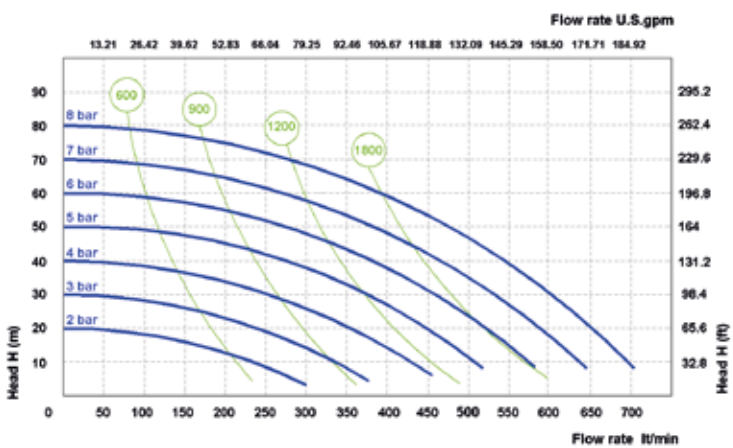

Duotek Food AF1000

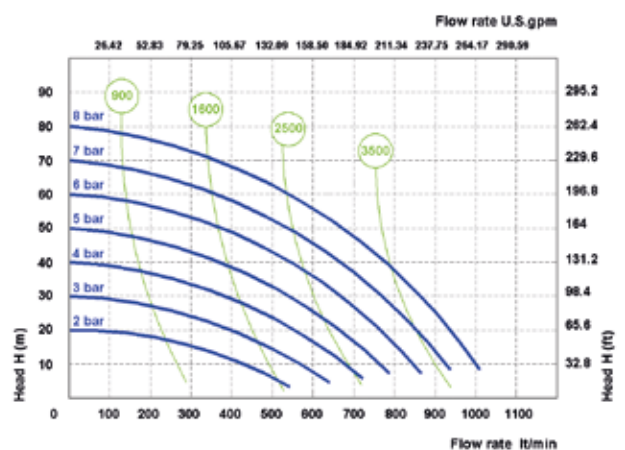

Special pumps

Air operated double diaphragm pumps with special features

DUOTEK ATEX certification zone1 ATEX
ACCURATE DUOTEK remote control
DRUM DUOTEK to empty drums and tanks
TWIN DUOTEK with double inlet/outlet



Special Pumps Duotek Atex



Technical data

Appropriate submissions have been made to Bureau Veritas to confirm that SEKO AODD pumps and pulsation dampers conform to the ATEX Directive 94/9/CE and are constructed with materials for zone 1 certification.

Main applications

- Petrol-Chemical Industry
- Painting industry
- Flexographic industry
- Automotive industry
- Food industry



PP + CF POMc + CF PVDF + CF ALU SS 

Pumps

AF7; AF18; AF30; AF50; AF65;
AF100; AF160; AF250; AF400;
AF700; AF1000

European ATEX Directive 94/9/CE

 II 2/2 GD c IIB T 135°C

 Safety symbols DIN 40012 Annex A

II Equipment Group surface

2/2 Equipment category 2 Level of protection - High level - Zone 1

GD Type of explosive atmospheres (group II)

G = Gas vapours

D = Dust

c Equipment protection constructional safety (EN 13463-5).

IIB Group of gas IIB Ethylene. Exclusion of the following products Hydrogen, acetylene, carbon disulphide.

T 135° (T4)

Temperature class (group II): Maximum surface temperature [°C] 135

Special Pumps

Accurate Duotek

Technical data

ACCURATE DUOTEK Pumps give you the necessary external pump control for exacting applications such as batching. Featuring a direct electrical interface that utilizes electrical impulses to stroke the pump instead of differential pressure, the ACCURATE DUOTEK provides an easily controlled variable stroke rate.

Note PLC and computer system not included.

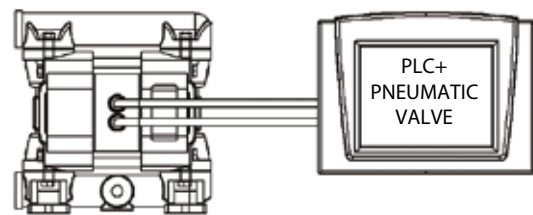
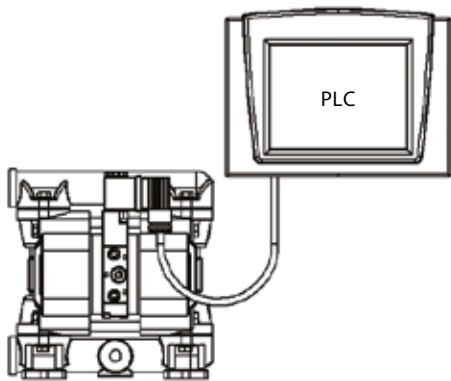

Main applications

- Chemical industry
- Flexographic industry
- Painting industry
- Wastewater technology
- Printing industry

Pumps

AF7; AF18; AF30; AF50;
AF65; AF100; AF160;
AF250



Special Pumps

Drum Duotek

Technical data

DRUM DUOTEK are designed for emptying drums and containers, and provide an economical and wear resistant alternative to other pumping systems. In order to handle a wide range of fluids, DP pumps are available in all materials. The pump can be quickly and easily mounted on the drum with its feet. The drum will be completely emptied with a suction pipe.

Main applications

- Chemical industry
- Waste disposal technology
- Automotive industry
- Food industry

Pumps

AF18; AF30; AF50;
AF65; AF100; AF160



Special Pumps

Twin Duotek

Technical data

TWIN DUOTEK are mainly used in the textile and paper processing industry. These dual action pumps are able to transfer two different media independently and simultaneously. This is accomplished by using separate connections on the suction and discharge ports, keeping two pumped media isolated from each other, preventing unwanted mixing.

Main applications

- Chemical industry
- Flexographic industry
- Painting industry
- Wastewater technology
- Printing industry

Pumps

AF18; AF30; AF50; AF65;
AF100; AF160; AF250;
AF400



Damper

Pneumatic, automatic pulsation dampers

Made in PP, PVDF, ALUMINIUM, SS AISI 316, POMc

Applicable to all size of pumps

Available also in ATEX or FOOD version



The active pulsation damper is the most efficient way to remove pressure variations on the discharge of the pump. SEKO pulsation damper work actively with compressed air and a diaphragm, automatically setting the correct pressure to minimize the pulsations. Pulsation dampers require minimum maintenance and are, subject to the requirements of the application, available in the same housing and diaphragm materials as the pump.

Applications

- Metering/ Injection/Dosing
- Equalizes discharge pressure spikes, increasing accuracy
- Filter Press/In-line Filters
- Increases filter efficiency and life by providing a smooth flow
- Spraying
- Smooth, consistent spray pattern
- Filling
- Eliminates inconsistent filling and splashing.
- Transfer
- Eliminates harmful water hammer, preventing pipe and valve damage



Significant Pulsation Reduction with an average 70% - 80% pulsation reduction in high back pressure applications.

How it works

The pulsating flow of the discharge forces the diaphragm upwards where it is cushioned by the air in the chamber. The flexing of the diaphragm absorbs the pulsation giving a smooth flow.

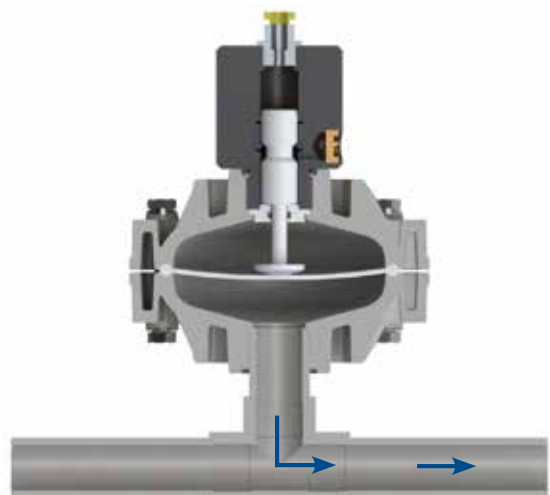
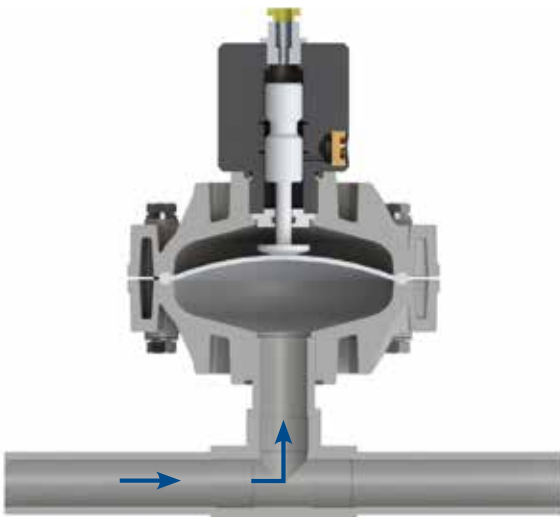
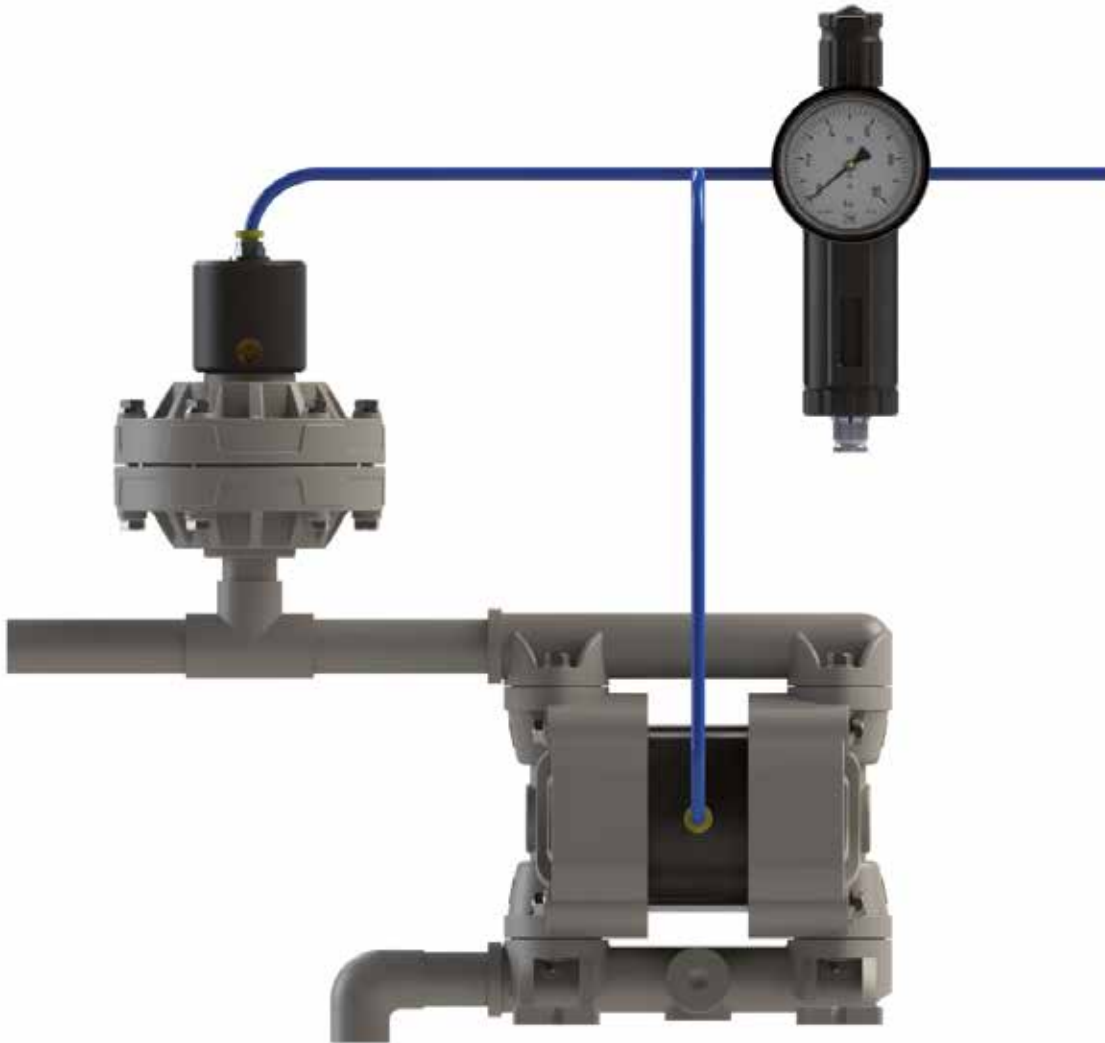

Damper DAF20

Technical data

Fluid connections	3/4"
Air connection	6 mm
Max air pressure	8 bar

APPLY TO
7 - 18 - 30



Damper DAF25

Technical data

Fluid connections	1"
Air connection	8 mm
Max air pressure	8 bar

APPLY TO
50 - 65 - 100



Damper DAF40

Technical data

Fluid connections	1"1/2
Air connection	10 mm
Max air pressure	8 bar

APPLY TO
160 - 250 - 400

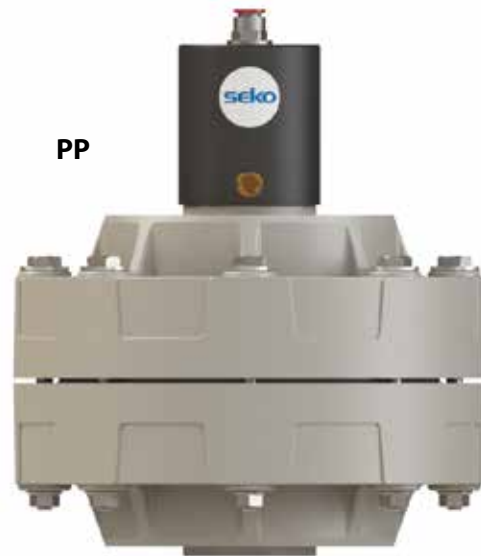

PP



PVDF+CF



POMc



SS

Damper DAF50

Technical data

Fluid connections	2"
Air connection	12 mm
Max air pressure	8 bar

APPLY TO
700 - 1000



PP



PVDF+CF



ALU



SS

Accessories



AIR REGULATION KIT

Adjust and set air pressure and air flow rate with a filter regulator, pressure gauge and air valve unit.



SWITCH VALVES

Remotely start and stop with a solenoid or pneumatic valve for the air pump.



STROKE COUNTER

Counts the number of strokes, connected to a control. It allows various types of monitoring.



INOX TROLLEY

Allows pumps to be transportable



ANTI VIBRATION FEET KIT

Reduces physical vibration from AODD pump operation.



FLANGE CONNECTION KIT

Adapt a pump from BSP type connection to flanges with this kit.



DIAPHRAGM FAILURE DETECTION FLUI-GUARD

The Electronic Leak Detector provides a signal via warning lights, an audible alarm, and the pump can be shut down.



PNEUMATIC OR ELECTRONIC BATCH CONTROL

Pneumatic and electronic batcher can control any SEKO AODD pump allowing you to set the cycles amount.

Notes

A large grid of graph paper for taking notes, consisting of 20 columns and 30 rows of small squares.

Notes

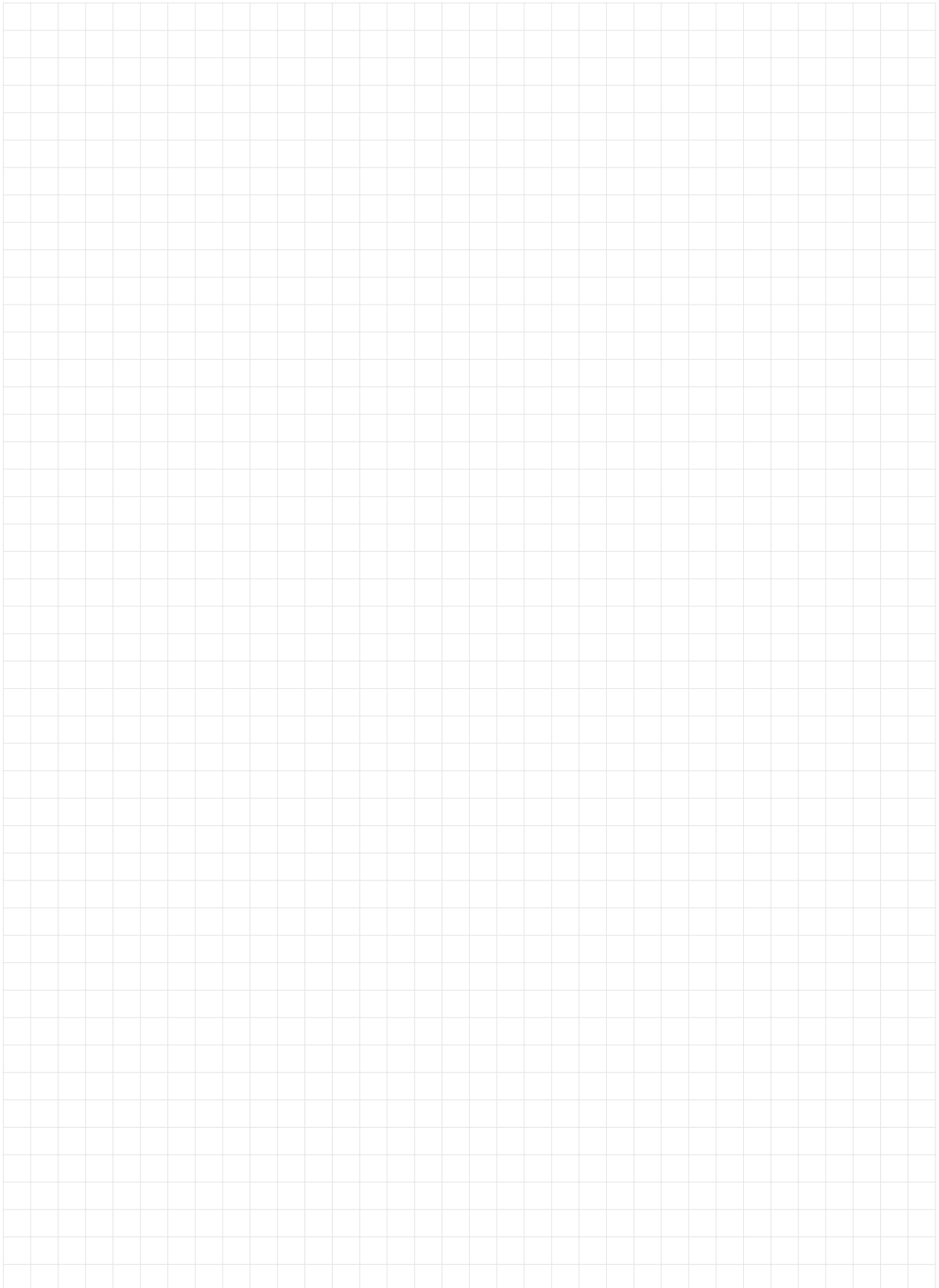

Notes

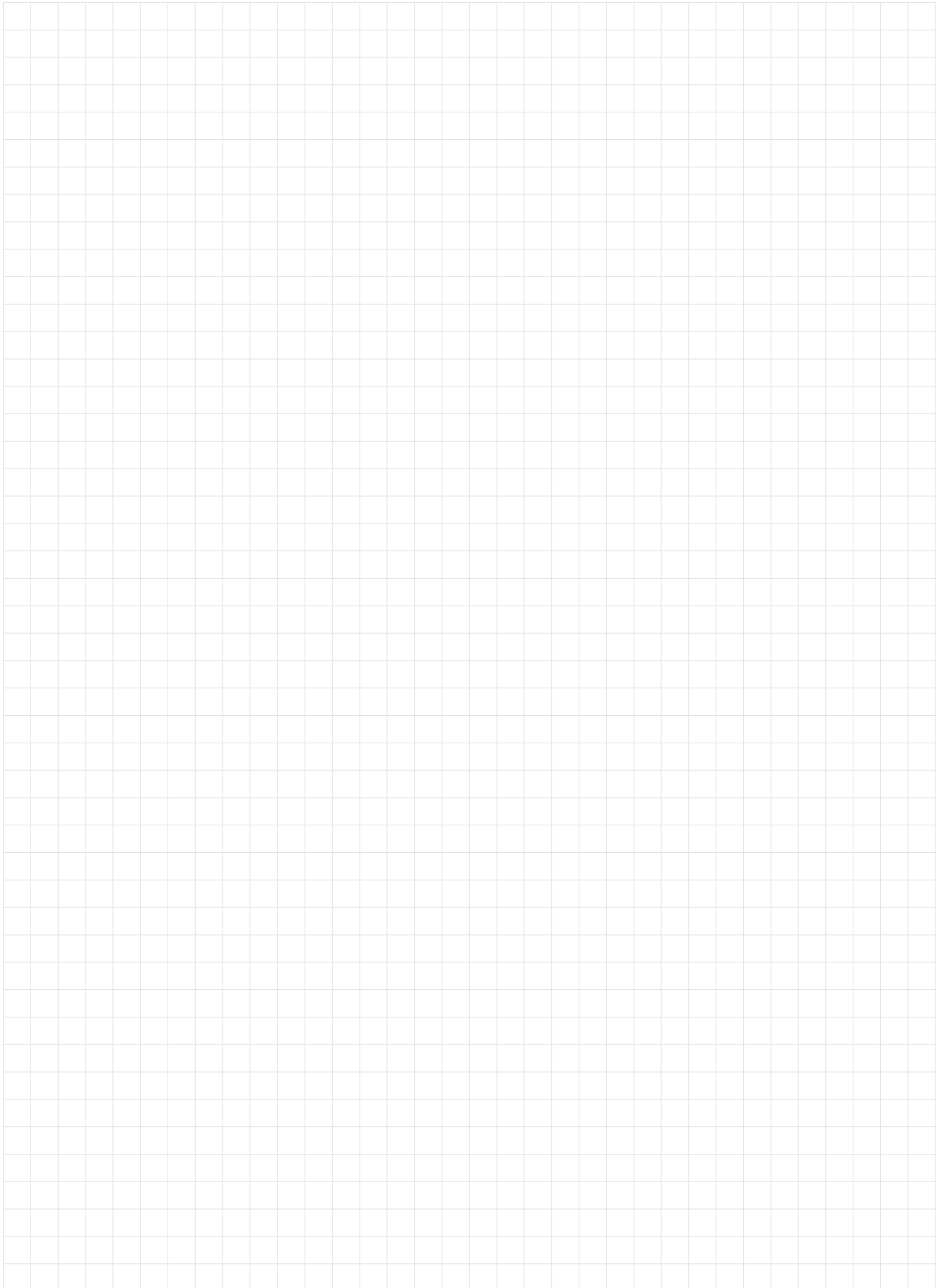

Your Choice, Our Commitment

In the modern Globalised world, being a privately owned Company has significant benefits especially for our Customers, our Partners. For over 40 years, SEKO has developed a Global organisation able to take the longer view, manage the pressure of the now, and to plan for the long term, delivering true Partnership for our Customers, with transparency and mutual respect for each other.

Whether it's for our reknown flexibility, our attention to detail, the high-quality products, or just the way we do business, we understand that it's Your Choice to do business with us. It is Our Commitment to fulfill your needs wherever you, our Customers are.



For more information about our portfolio, worldwide locations, approvals, certifications, and local representatives, please visit www.seko.com



SEKO reserves the right to amend and change specifications without prior notice. All pictures shown are for illustration purpose only. Actual product may vary due to product enhancement. Published data may be subject to change.

© 2018 SEKO, Layout and origin: UK, 850001 AODDWI EN V03

info@createflow.cz
www.createflow.cz

Crete Flow s.r.o.

tel: 00420 722 712 652